

## SAFETY INSTRUCTIONS

---

1. Please read these safety instructions carefully.
2. Please keep this User's Manual for your reference.
3. Please disconnect the equipment from your AC outlet before cleaning.  
Do not use liquid or sprayed detergent for cleaning.  
Use moist sheet or cloth for cleaning.
4. For pluggable equipment, the socket-outlet shall be installed near the equipment and shall be easily accessible.
5. Please keep this equipment away from humid areas.
6. Install this equipment on a reliable surface. If the equipment is not on a reliable surface, it may drop and cause injury.
7. The openings on the enclosure are for air convection. Please protect the equipment from overheating . **DO NOT COVER THE OPENINGS.**
8. Make sure the voltage of the power source is appropriate when connecting the equipment to the power outlet.
9. Place the power cord where people will not step or trip on it. Do not place objects over the power cord.
10. All Cautions and Warnings on the equipment should be noted.
11. If the equipment is not in use for several days, disconnect the equipment from the power outlets to avoid damage by transient power surges.
12. Never pour any liquids into the openings, this could cause fire or electrical shock.
13. Never open the equipment. For safety reasons, the equipment should only be opened by qualified service personnel.
14. If one of the following situations arises, get the equipment checked by a qualified service personnel:
  - (a) The power cord or plug is damaged.
  - (b) Liquid has penetrated into the equipment.
  - (c) The equipment has been exposed to moisture.
  - (d) The equipment has not worked well or you can not get it to work according to the user's manual.
  - (e) The equipment was dropped and damaged.
  - (f) If the equipment has obvious signs of damage.
15. **DO NOT LEAVE THIS EQUIPMENT IN AN ENVIRONMENT UNCONDITIONED; STORAGE TEMPERATURE ABOVE 60°C (140°F), IT MAY DAMAGE THE EQUIPMENT.** The sound pressure level at the operators position according to IEC704-1:1982 is equal or less than 70dB(A)
16. **DANGER:** Invisible laser radiation when opened. Avoid direct exposure to beam. Complies with FDA radiation performance standards, 21 CFR, subchapter J.  
Laser power: Wave Length: 783±3nm (CD); 658±3nm (DVD)  
Emission power: 0.7mW  
Laser diode: class 3b

## PRECAUTIONS

---

**!! Do not attempt to open the drive and service it. Removing the cover may cause exposure to harmful laser beams and electrical voltage. User is recommended to get service by returning the defective drive back to the original vendor where the drive was purchased.**

- Use the original package for transporting the drive or sending back for service. The original packing was designed and tested to protect your drive under rough conditions.
- Do not put this drive in direct sunlight, on heating units, or near electrical appliances which draw large amounts of current.
- Use a soft, dust-free cloth for cleaning your drive. Keep your drive away from moisture or liquids including water, cleaning-fluids, or solvents.
- Keep your disc clean. Using a soft, dust-free cloth to clean the surface of the disc before recording will improve the burning data integrity.
- Do not drop or jolt the drive.
- Keep the area around the drive clean from dust, smoke, and other contaminants.
- The copyright law of each country governs the reproduction of copyrighted works. The person using the drives may be liable for its use to make unauthorized copies of copyrighted works.
- It will increase the success rate for copying the data from HDD, instead of copying the data by "copy on the fly mode". Therefore we recommend the user reserving sufficient buffer space for creating an image file (at least 650MB for CD; 5GB for DVD; and if your drive support Double Layer DVD+R writing, then at least 9GB space is needed).

## **TABLE OF CONTENTS**

---

### **INTRODUCTION**

What the DVD Writer Does.....	4
Format Compatibility.....	4
Recording Modes.....	5
What You Can Do with the DVD Writer.....	5

### **System Configuration**

System Requirements.....	6
--------------------------	---

### **Features and Controls**

Front View.....	7
Rear View.....	8

### **INSTALLATION**

#### **USB 2.0 Users**

Installing USB Driver for Windows 98SE.....	9
---	---

<b>Connection</b> .....	10
-------------------------	----

<b>Installing the Drive</b> .....	11
-----------------------------------	----

### **OPERATION**

<b>Installing Necessary Device Drivers</b> .....	12
--	----

<b>Loading and Unloading the Tray</b> .....	12
---	----

#### **Recording CDs & DVDs**

About Software & Manuals.....	13
Recommended Recordable & ReWritable Media.....	13

#### **Playing CDs & DVDs**

Playback Software.....	14
Playing Audio CDs.....	14
Playing DVDs for the First Time.....	15

### **TROUBLESHOOTING**

Read Problems.....	16
Write Problems.....	17

## INTRODUCTION

---

Thank you for purchasing this DVD Writer, a reliable, high-performance recordable DVD and CD writer, rewriter and player. Please read this manual carefully and keep it handy for easy reference. Use the manual for installation, operation and troubleshooting for this drive.

### What the DVD Writer Does

The DVD Writer is a recordable DVD/CD-ReWritable drive that provides professional quality DVD and CD performance for writing, rewriting and reading. It also reads Digital Versatile Discs (DVDs) formatted for movies and data. This versatile and remarkable drive can:

#### For DVDs

- Write DVD+R (recordable DVD) media.
- \* Write Double Layer DVD+R (recordable DVD+R9) media.
- Write DVD+RW (re-writable DVD) media.
- Write DVD-R (recordable DVD) media.
- Write DVD-RW (re-writable DVD) media.
- Read DVD (DVD+R, DVD+RW, DVD-R, DVD-RW, and DVD+R9) discs.

#### For CDs

- Write to CD-R (recordable CD) media.
- Write to ultra-speed CD-RW (rewritable CD) media.
- Read all CD-ROM and CD-R data media.
- Read CD-RW and CD-DA (audio) media.

**(NOTE: The drive's maximum Writing, ReWriting, & Reading speeds are printed on the original box. \*Only when your drive supports Double Layer DVD+R writing, it can write DVD+R9 media.)**

The drive supports Running OPC (ROPC) and is compatible with Windows Plug & Play. Flash memory allows upgrading the drive to the latest firmware revision (available from the web site) without opening the drive. Buffer Underrun Proof technology eliminates buffer underrun errors, therefore you can safely use your computer for other things while you're writing to a recordable DVD and CD media.

### Format Compatibility

This DVD Writer is a versatile optical disk drive. For CD write function, it is capable to write data, which conforms to Orange Book: Part 2 CD-R Volume 1 / Part 2 CD-R Volume 2 Multi Speed / Part 3 CD-RW Volume 1 (known as Low Speed) / Part 3 CD-RW Volume2: High Speed / Part3 CD-RW Volume 3: Ultra Speed, into CD-R/RW disk in combination with write application software. For DVD write function, this drive conforms to DVD+R Version 1.2 / DVD+R9 Version 1.0 (only for a Double Layer DVD+R writing support drive) / DVD+RW Version 1.11 / DVD-R Recordable Disc Part1 Ver2.0 / and DVD-RW Re-recordable Disc Part1 Ver.1.0. For read function, it is capable to read all of the following media: DVD single/dual layer (PTP, OPT), DVD-R, DVD+R, DVD-RW, DVD+RW. Besides, it reads all of CD formats and media: CD-DA, CD-ROM, CD-ROM/XA, Photo-CD, Multi-session, Karaoke-CD, Video CD, CD-I FMV, CD Extra, CD Plus, CD-R, and CD-RW.

---

---

## Recording Modes

### Track at Once

Data can be recorded to a disc, one track at a time. New tracks can be added later. Music CDs can not be played in a CD player or CD-ROM until the disc is closed.

### Disc at Once

Data can be recorded to an entire disc in one pass. In this mode, new data added later is not allowed.

### Session at Once

Data can be recorded to disc one session at a time. New sessions can be written later in this mode. More disc space can be used because there is no gap between tracks.

### Multi session

Data can be recorded to disc in one session. New sessions can be written later in this mode. Less disc space can be used because a gap is created between sessions.

### Packet Writing

This is useful for data back up. Data can be added directly to tracks on media or can be deleted directly from tracks only on media. To use this mode, your software must support Packet writing function.

## What You Can Do with the DVD Writer

- Record digital video or slide shows onto DVD+R, DVD+RW, DVD-R, and DVD-RW discs.
- \*A Double Layer DVD+R writing support drive will be able to write DVD+R9 disc.
- Play DVD+R, DVD+RW, DVD-R, and DVD-RW discs.
- Record data or audio onto recordable or rewritable CD media.
- Play music CDs.
- Play VCD & DVD movies.
- Access interactive reference materials stored on DVD.
- Save photos and other images on recordable or rewritable CDs.
- Archive images and video to DVD or CD.
- Master new software programs on DVD or CD.

## SYSTEM CONFIGURATION

### System Requirements for USB 1.1

This drive has a high-speed Universal Serial Bus (USB) 2.0 interface. You can also use it with USB version 1.1. To ensure stable read/write/rewrite performance, an IBM compatible PC system with the following features is recommended.

CPU	Pentium III 450 MHz or higher with built-in USB 1.1 controller (some USB controllers or motherboards may not support all types of USB devices.)
OS	Microsoft Windows 98SE/ME/2000/XP
Memory	Must meet recommended RAM requirements for your operating system. (minimum 256MB is recommended)
CD-ROM Drive	For software installation
Hard Drive	Minimum 650MB available capacity for creating a CD image file; 5GB free HDD space for creating a DVD image file to a Single Layer DVD disc (4.7GB); *and 9GB or above free HDD space for creating a DVD image file to a Double Layer DVD+R disc (8.5GB). (Do not enable HDD thermal calibration during operation)
Interface	USB interface connector

**NOTE:**

- (1) Connecting USB 1.1 interface the drive's top performance is 4X for CD-R, 4X for CD-RW and 6X for reading a CD-ROM. In addition, DVD speed is limited to 0.7X. Therefore, we strongly suggest you NOT to apply any DVD function when connected with USB 1.1 interface.
- (2) Some high-speed hard drives are equipped with an "Auto Thermal Re-calibration" function. Please disable it in the BIOS setup to avoid writing errors (Buffer Under-run).

### Additional Requirements for USB 2.0

Interface	High Speed USB 2.0 interface required to achieve maximum speeds
-----------	---

**NOTE:**

- (1) High Speed USB 2.0 adapter card is sold separately and will not be bundled in this package.
  - (2) To achieve maximum record/write speed your system may require data to be copied first to the computer's hard drive rather than directly from another source disc or drive.
- \*Check the original box to see if your drive supports writing to a Double Layer DVD+R disc.**

## FEATURES AND CONTROLS

### Front View

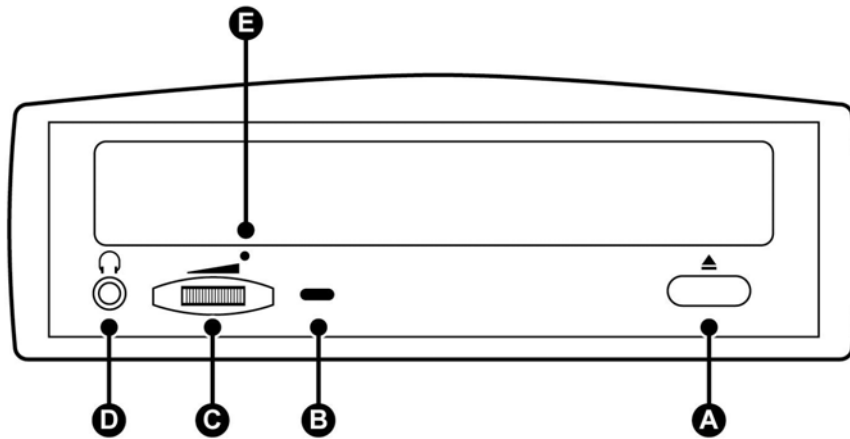
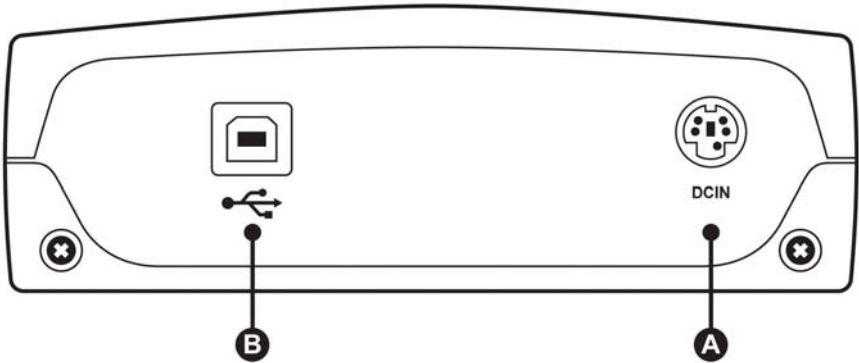

Figure: Front view of DVD Writer

<b>A</b>	<b>Eject/Close Button</b>	Push button to eject/close the tray.
<b>B</b>	<b>Busy / Write LED</b>	Indication of drive's operation status. The light lit stands for Busy; the light blinking stands for Write/Rewrite.
<b>C</b>	<b>Volume Knob</b>	Control volume of earphone jack. This control has no effect on rear panel audio output.
<b>D</b>	<b>Earphone Jack</b>	Stereo mini-jack for headphones and powered speakers.
<b>E</b>	<b>Emergency Eject Hole</b>	In case the Eject button isn't working, insert a small stick or paper clip into this hole to eject the tray. <i>Note: Turn off the power before doing this manual ejection.</i>

**Rear View**



*Figure: Rear view of DVD Writer*

<b>A</b>	<b>Power Connector</b>	Five-pin connector for DC power input.
<b>B</b>	<b>USB Connector</b>	Standard USB B type jack.

## USB 2.0 USERS

---

USB 2.0 is a very new technology. Therefore, most computers do not have native support for USB 2.0. You must install a USB 2.0 adapter card for your External drive to run at USB 2.0 speeds. If you do not have a USB 2.0 card installed, this drive will still work connected to a standard USB 1.1 connection, but the speed will be limited to USB 1.1 speed. After installing a USB 2.0 adapter card, follow the steps below for your operating system to verify the USB 2.0 card is installed properly.

### **Windows® 98SE/ME users:**

Right click My Computer and select Properties.

Select the Device Manager tab.

If there is a yellow exclamation point next to Universal Serial Bus Controllers, contact the card's manufacturer for help.

### **Windows® 2000/XP users:**

Right click My Computer and select Properties.

Select the hardware tab.

Click the Device Manager button.

If there is a yellow exclamation point next to Universal Serial Bus Controllers, contact the card's manufacturer for help.

### **Instructions on Installing the USB Driver for Windows 98SE:**

This USB drive is a Plug&Play USB storage device. If you are using any of the following Operating Systems: such as Windows ME, Windows 2000, and Windows XP, all you need to do is plug it to your computer properly. Then the drive is ready to use.

Whereas, a PC using the Windows 98SE OS will not recognize this USB drive if you are installing this drive for the first time. Therefore, you will need to install a driver into your computer for this USB drive to properly install to your computer.

You can find the USB driver for Windows 98SE OS either in the included Floppy Disc or in the USB driver for Windows 98 OS directory of the Burning Software kit. Please follow your OS instructions to install the driver for this USB drive, then restart your computer.

### **CAUTION:**

Please limit your CD recording speed to 4X or 8X if your computer is only equipped with a slower speed USB1.1 interface or if your PCMCIA port does NOT support Card Bus interface. Attempting high speed writing with a slow interface can cause frequent buffer overloading and writing pauses (when the Busy LED is blinking) that could adversely affect recording quality.

## CONNECTION

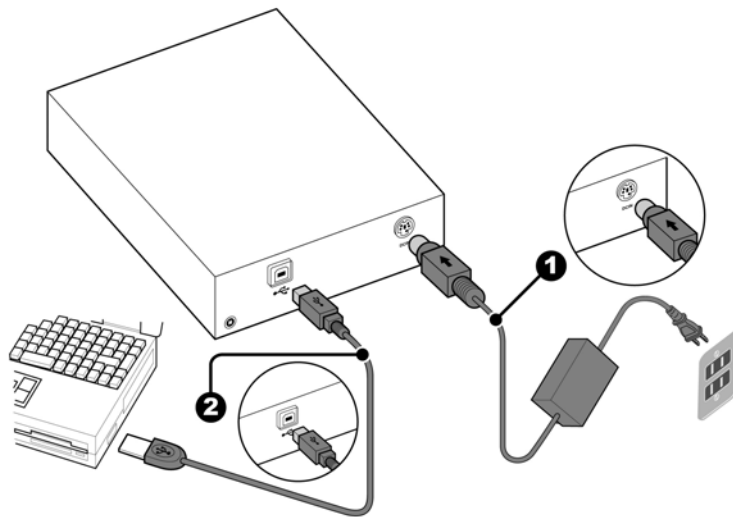

1. **Connecting the Power Supply Cable.**
2. **Connecting Hi-Speed USB 2.0 Cable.**
3. **(Optional) Connecting Powered Speakers or Headphones with Volume Control Function for Audio CD Playback.**

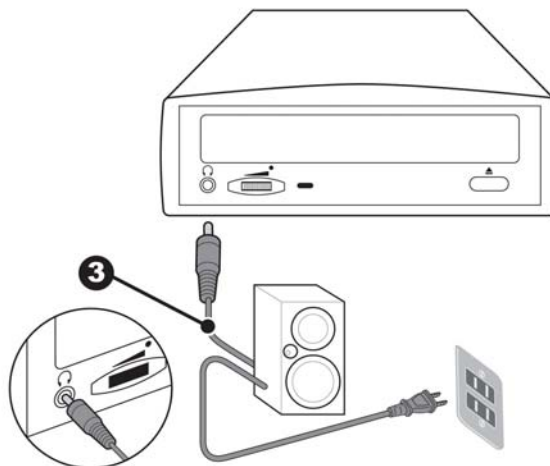

## INSTALLING THE DRIVE

---

**Before you start, please make sure you have installed the proper software for Recording CDs, DVDs and Playing DVDs. The Recording software and the DVD Playback software are in different CD kits included in the package.**

- 1. Start your computer. Wait for the operating system to load, then insert the CD kit. Follow the instructions on the screen to install the software for Recording CDs, DVDs or Playing DVDs you wish to install from the CD kit.**
- 2. Connect the power supply to the drive.**  
(To prevent damage to the power plug, connect carefully to avoid bending the power plug.)
- 3. Attach the included Hi-Speed USB cable B type plug to the drive.**  
(Examine the connection carefully for the correct orientation.)
- 4. Connect the A type plug end of the Hi-Speed USB cable to the USB 2.0 adapter card connection on your computer. The drive is ready to use.**  
(NOTE: If you cannot identify the USB 2.0 connection, refer to the documentation of your USB 2.0 card. If you do not have a USB 2.0 adapter card installed, you can still connect the drive to a standard USB 1.1 connection.)
- 5. Special notes for Windows 98SE user.**  
If this is the first time you are installing this USB drive to your Windows 98SE (Second Edition) Operating System, you will have to install a USB driver for your Windows 98SE. Follow the instructions on the screen to install the USB driver properly, then restart your computer. (For more details, please refer to the USB 2.0 Users page.)

### **(Optional) Audio Cable Connection for Audio CD Playback**

- 1. Connect the included audio cable to the drive.** (NOTE: Ensure the computer and the drive are off before connecting the audio to your computer.)
- 2. Connect the audio cable to the "Audio In" connector of your computer.** (NOTE: Only connect the audio cable to powered speakers or to headphones with volume control function.)

## OPERATION

### Installing Necessary Device Drivers

In Windows, the DVD Writer acts as a “CD-ROM Drive” for purpose of installation and setup. In some cases, you will need to install additional software to make use of all the features of the DVD Writer.

#### To use the DVD Writer on a computer:

- ◆ **As a CD-ROM drive:** Most Windows Operating Systems (Windows XP, Windows ME, Windows 2000, Windows 98, and Windows 95) supply a generic CD-ROM device driver that allows the DVD Writer to function as a standard CD-ROM drive. You do not need to install anything else.
- ◆ **As a DVD-ROM drive:** The computer’s operating system (excluding Windows 95) also allows the DVD Writer to function as a DVD-ROM drive. You do not need to install anything else to play DVDs. (In Windows 95, you will need additional software to play DVD media, which will be included with the DVD Writer software CD kit.)
- ◆ **As a CD ReWriter or DVD ReWriter:** In order to write to CD or DVD media, you will need additional software. The Recording software kit included with the package will offer you function like mastering, packet writing, duplicating, backing up your hard disk or files, capturing audio, and more.

### Loading and Unloading the Tray

- (1) While the DVD Writer is powered up, push the Eject button on the front panel. The tray drawer slides out in a few seconds.
- (2) Lay a disc with the label facing up in the depression of the tray. The disc should lie flat in the tray.

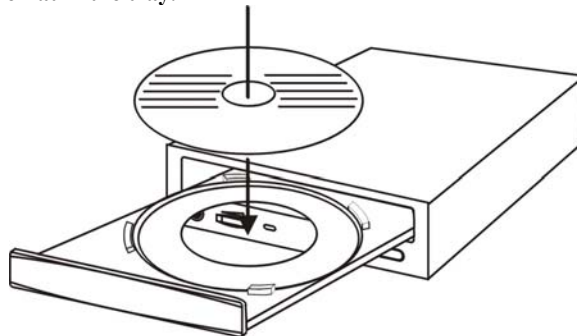

Figure: Loading the Tray

- (3) Press the Eject button again and the tray will slide shut within seconds.

## RECORDING CDs & DVDs









**Before you start, please make sure you have installed the proper software for Recording CDs, DVDs and Playing DVDs. The Recording software and the DVD Playback software are in different CD kits included in the package.**

### About Software & Manuals

The included software is to give you the best result with ease of use. The detailed user's manual for the recording and playback software will be automatically installed into your computer when you install the recording software. For details on other software packages that are available for writing DVDs or CDs, please visit the web sites of the companies whose software you are interested in, refer to their user's manual, or look at the help option within the software. Please refer to the user's manual for the detailed operation procedures.

### Recommended Recordable & ReWritable Media

Some CD media or DVD media may not be possible to write on, due to differences in the manufacturing quality. We recommend you use CD and DVD media from the following manufacturers that have been proven satisfactory with our drive.

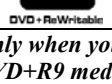
CD-R Media:		CMC, Daxon, DST, Fonet, Fujifilm, GAT, Gigastorage, Infodisc, KingPro LeadData, Maxell, Mitsubishi, MPO, NanYa, Plasmon, Postech, Princo, Prodisc, RAMedia, Ritek, SAST, SKC(Korea), Sony, TDK, Taiyo-Yuden, Xeitek
Low Speed CD-RW Media:		CMC, Daxon, Gigastorage, Infodisc, LeadData, Mistubishi, Princo, Prodisc, Ricoh, Ritek
High Speed CD-RW Media:		CMC, Daxon, Fonet, Gigastorage, Infodisc, LeadData, Mitsubishi, NanYa, Princo, Prodisc, Ricoh, Ritek
Ultra Speed CD-RW Media:		CMC, Daxon, Infodisc, Mitsubishi, Prodisc, Ritek
DVD-R Media:		CMC, GSC, Maxell, Mitsubishi, Prodisc, Ritek, Sony, Taiyo-Yuden
DVD-RW Media:		Mitsubishi, Ritek
DVD+R Media:		CMC, Maxell, Mitsubishi, Philips, Prodisc, Ricoh, Ritek, Sony, Taiyo-Yuden
DVD+R9 Media:		Mitsubishi, Ricoh
DVD+RW Media:		CMC, Daxon, Infodisc, Mitsubishi, Philips, Prodisc, Ricoh, Ritek, Sony

**NOTE:** (1) Only when your drive supports Double Layer DVD+R writing can write DVD+R9 media.

(2) The drive's maximum Writing, ReWriting, & Reading speeds are printed on the original box.

(3) Subject to change without further notice.

## PLAYING CDs & DVDs

### Playback Software

You must install the DVD playback software to your computer first. If you do not have any DVD playback software installed in your computer, the included DVD playback software in the CD kit will bring you the best playback result.

You can immediately play Audio CDs and pre-recorded DVD discs, including movies and other DVDs. To play a CD or a Digital Video Disc (DVD), insert the disc with the label up (for CDs). This DVD Writer plays both single-layer and dual-layer DVDs.

### Playing Audio CDs

In order to listen to an audio CD, connect an audio cable to the analog audio connector on the rear of the drive and connect the other end to your sound board.

There are two types of audio you may encounter:

- (1) **CD-Audio:** This comes from audio discs (like the ones you use in your home stereo) that are translated directly by your DVD Writer into sound. Although, in most cases a sound board and speakers are used to hear this audio, you can also listen to it by plugging a set of headphones or powered speakers into the earphone jack on the front of your drive. You can control audio playback through software, and adjust the volume with the front panel volume control.



*Figure: Using the Earphone Jack for Playing Audio*

- 
- (2) **Sound Board Audio:** This comes from data files that may be present on a disc, such as a WAV, WMA, or MP3 files, that are transferred from the CD to your computer via the USB interface. The sound board translates the data from the digital files into analog sound. If you do not have a sound board, you will not be able to hear this form of audio from your DVD Writer.

To listen to music through the computer's sound board, you can control volume with the volume control on the Windows Media Player or CD Player Taskbar. You can also mute the sound on your sound board and listen to music through headphones or self-powered speakers.

### **Playing DVDs for the First Time**

A code on some DVDs allows them to be played only in a certain regional area, such as North America, Europe, etc. When the DVD Writer ships, there is no region code set. The first time a DVD that has a region setting is inserted into the DVD Writer, the act of inserting the DVD sets the drive to that region code.

If you later insert a DVD with a different region code, you are prompted to either accept changing the region code or not. If you do not accept the change, then that DVD will not play. If you do accept the change, then the DVD Writer's region code setting is changed. **But advised that you may change the DVD Writer's region code only 5 times. After that, you will not be able to change your drive's code setting.**

## TROUBLESHOOTING

If you meet any trouble during installation or normal use of your drive, please refer to the following information.

### Read Problems

Symptom	Possible Causes	Solutions
No operation.	No power.	<ul style="list-style-type: none"> <li>Check if the power cord is connected securely to the connector.</li> </ul>
	USB cable isn't connected properly.	<ul style="list-style-type: none"> <li>Ensure that the USB cable and connectors are not damaged, bent or dented. Check especially the pins.</li> </ul>
No drive recognition.	Power is not switched on.	<ul style="list-style-type: none"> <li>Check if LED of your drive is lit. If not, there is no power.</li> </ul>
	USB cable is not connected properly between the computer USB port and the drive.	<ul style="list-style-type: none"> <li>Ensure that both connectors of the USB cable is properly connected to the USB ports on the computer and the drive.</li> </ul>
	USB drive is not recognized by the Windows Operating System.	<ul style="list-style-type: none"> <li>Please refer to the USB 2.0 Users chapter and check if the USB driver is installed properly.</li> </ul>
Excessive noise when reading.	Eccentric disc loaded.	<ul style="list-style-type: none"> <li>Replace it with another one.</li> </ul>
	Seal attached on the surface	<ul style="list-style-type: none"> <li>Detach the seal very carefully. Don't make any scratches.</li> </ul>
Cannot open the tray (Eject).	Eject locked by software.	<ul style="list-style-type: none"> <li>Stop the applying software and try the eject button to open the tray.</li> </ul>
	CD set incorrectly.	<ul style="list-style-type: none"> <li>Insert a small stick or paper clip into this hole to eject the tray.</li> </ul>
<ul style="list-style-type: none"> <li>Cannot read the former session of the CD-RW disc which has been written at least twice.</li> <li>Read error occurs.</li> </ul>	"Load Contents" or "Import Session" was NOT clicked on the Software.	<ul style="list-style-type: none"> <li>If recorded without checked "Load Contents" or "Import Session", it is impossible to read. But when using utility software such as "Session Selection" from Adaptec, the former session can be read.</li> </ul>
	Defective disc.	<ul style="list-style-type: none"> <li>Deep scratches, fingerprints or other contaminants on the discs surface can disable the drive from reading data. Always keep it clean.</li> </ul>
	Music CD inserted.	<ul style="list-style-type: none"> <li>Because audio compact discs do not have computer data, typing computer commands while an audio CD is in your drive will result in an error message.</li> </ul>
	Disc inserted upside down.	<ul style="list-style-type: none"> <li>Remove the disc from tray and reinsert it with the label side up.</li> </ul>

**Write Problems**

Symptom	Possible Causes	Solutions
Cannot write.	Using other authoring software which does not support your drive.	<ul style="list-style-type: none"> <li>Use the authoring software provided with the drive. When using other software, ensure your drive is supported by contacting the software supplier.</li> </ul>
	Disc inserted upside down.	<ul style="list-style-type: none"> <li>Reinsert the disc with label side up.</li> </ul>
	Short of Hard Disk capacity.	<ul style="list-style-type: none"> <li>Generally 1.2 to 2 times the size of the write data is required. This may vary according to the write method.</li> </ul>
	No power.	<ul style="list-style-type: none"> <li>Check if the power cord is securely connected to the connector.</li> </ul>
	USB cable isn't connected properly.	<ul style="list-style-type: none"> <li>Ensure that the USB cable and connectors are not damaged, bent or dented. Check especially the pins.</li> </ul>
Writing errors occur (Buffer under-runs).	<ul style="list-style-type: none"> <li>Network used.</li> <li>Window screen saver activated while writing.</li> <li>Other application running.</li> </ul>	<ul style="list-style-type: none"> <li>When running saver or other applications or writing in a network environment, errors may occur due to lack of CPU resources in PC.</li> <li>Rewrite after log-off from the network.</li> <li>Deactivate the screen saver or power saving mode.</li> <li>Quit other applications other than the authoring software.</li> </ul>
	Short of PC memory.	<ul style="list-style-type: none"> <li>Due to shortage of main memory in PC, swapping of hard disc space may have occurred. If swapped, data from the hard disc may cut off causing buffer under-runs.</li> <li>Increase main memory capacity.</li> </ul>
	"Auto thermal re-calibration" triggered.	<ul style="list-style-type: none"> <li>Disable "Auto thermal re-calibration" in the BIOS setup.</li> <li>Use another Hard Disk if can not disable it.</li> </ul>
	Defective DVD/CD media.	<ul style="list-style-type: none"> <li>DVD/CD media may be dirty, scratched or damaged. Rewrite on another DVD/CD media.</li> </ul>
	Short of Hard Disk capacity.	<ul style="list-style-type: none"> <li>Generally 1.2 to 2 times the size of the write data is required. This may vary according to the write method.</li> </ul>
No drive recognition.	USB cable is not connected properly between the computer USB port and the drive.	<ul style="list-style-type: none"> <li>Ensure that both connectors of the USB cable is properly connected to the USB ports on the computer and the drive.</li> </ul>

Symptom	Possible Causes	Solutions
	USB drive is not recognized by the Windows Operating System.	<ul style="list-style-type: none"> <li>Please refer to the USB 2.0 Users chapter and check if the USB driver is installed properly.</li> </ul>
	Using other authoring software which does not support your drive.	<ul style="list-style-type: none"> <li>Use the authoring software provided with your drive. When using other software, ensure your drive is supported by contacting the software supplier.</li> </ul>
Can not write at highest speed.	DVD/CD media not compatible with highest speed.	<ul style="list-style-type: none"> <li>Use the highest speed compatible discs or write with lower speed.</li> </ul>
	Buffer under-run occurs.	<ul style="list-style-type: none"> <li>Refer to the "Buffer under-run" item.</li> </ul>
	Defective DVD/CD media.	<ul style="list-style-type: none"> <li>DVD/CD media may be dirty, scratched or damaged. Rewrite on another DVD/CD media.</li> </ul>
	Using other authoring software not bundled with your drive.	<ul style="list-style-type: none"> <li>Use the authoring software provided with your drive. When using other software, ensure your drive is supported by contacting the software supplier.</li> </ul>